



opk E-SPACE

*Montage- und Bedienungsanleitung
Mounting- and Operating Instructions*

Inhaltsverzeichnis

Table of Contents

Anwendungsmöglichkeiten, Maßvorgaben, Maßberechnung	Page 1
<i>Possible applications, dimensions, dimension calculation</i>	
Türen Holz, Glas	Page 3
<i>doors wood / glass</i>	
Einstellung breite Türe	Page 5
<i>Adjustment wider door panel</i>	
Einstellung schmale Türe	Page 6
<i>Adjustment narrower door panel</i>	
Einzelne Türe	Page 8
<i>Single system</i>	
Türen synchro	Page 9
<i>double system</i>	
App-Installation	Page 14
<i>app installation</i>	
App Bedienung	Page 16
<i>app controlling</i>	
Technische Daten	Page 17
<i>Technical specifications</i>	
Einstellung und Korrektur des Synchrosystems	Page 18
<i>Adjustment and correction of the synchro system</i>	
Richtungsänderung der Türen	Page 18
<i>Abnormal moving direction – door panel</i>	

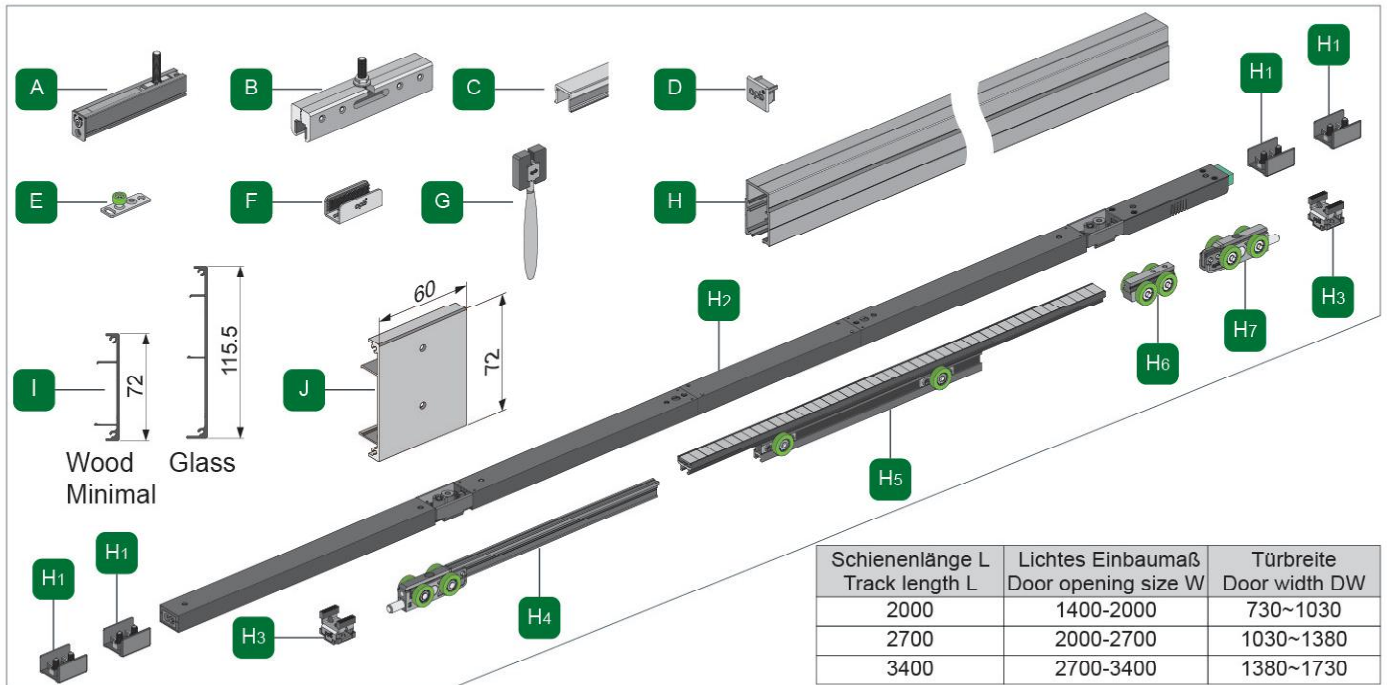

Wood Minimal

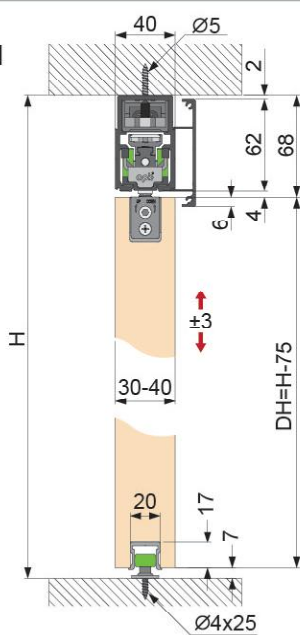

Wood Minimal

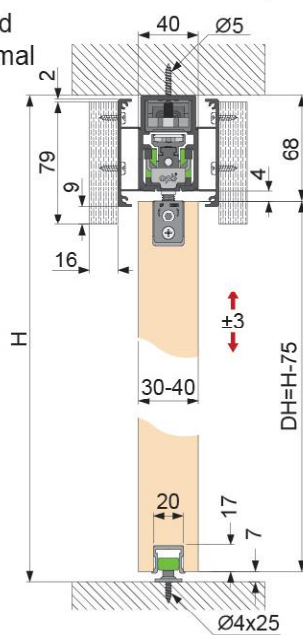

Glass

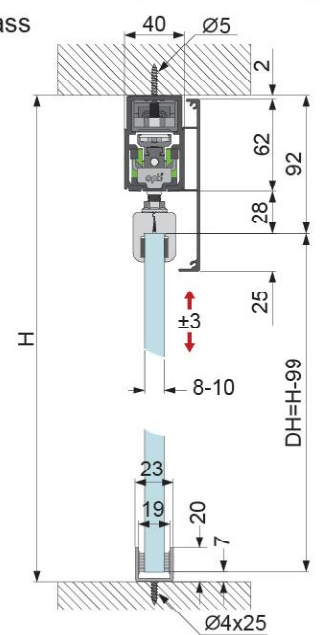

Wood Minimal

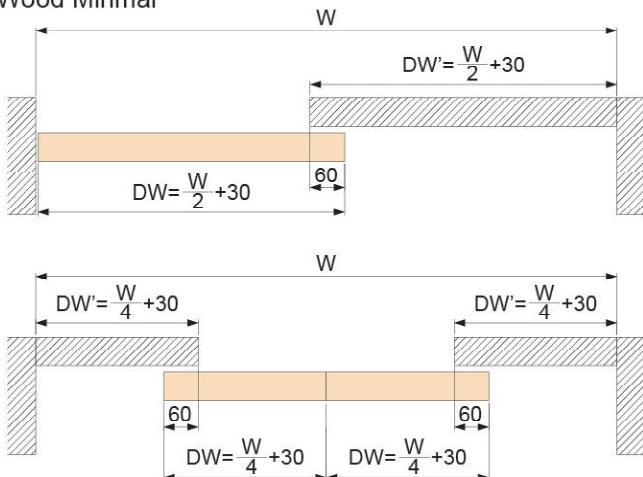

Glass

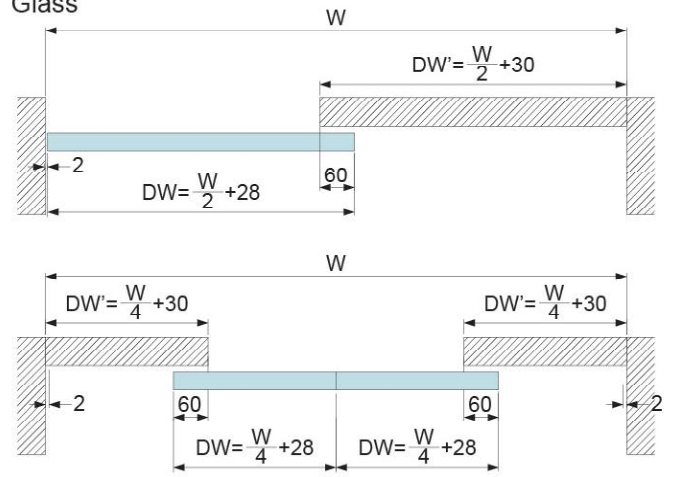

1

Single system / Schiene

! Immer auf beiden Seiten die gleiche Länge abschneiden, wenn die Schiene zu lang ist
 When the track system is too long then both sides need to be cut to the same length X

$X=(L-W)/2$
 Note:
 X: the length of cutting at both sides
 L: the track length delivered
 W: the door opening

Schiene Länge L Track length L	Lichtes Einbaumaß Door opening size W
2000	1400~2000
2700	2000~2700
3400	2700~3400

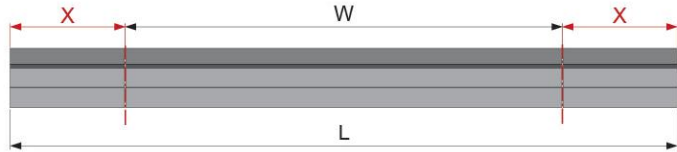

Double systems / Schienen (synchro system)

! Immer auf beiden Seiten die gleiche Länge abschneiden, wenn die Schiene zu lang ist
 When the track system is too long then both sides need to be cut to the same length X

$X=(L-W/2)/2$
 Note:
 X: the length of cutting at both sides
 L: the track length delivered
 W: the door opening

! An beiden Schienen die gleiche Länge X jeweils abschneiden (4x schneiden)
 Track System 1 and Track System 2 need to be cut to the same length X

Schiene Länge L Track length L	Lichtes Einbaumaß Door opening size W
2000 / 2000	2800~4000
2700 / 2700	4000~5400
3400 / 3400	5400~6800

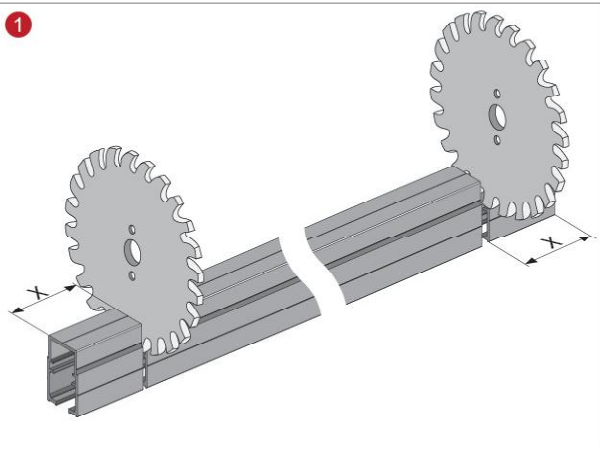
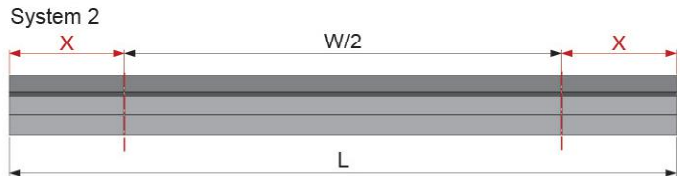
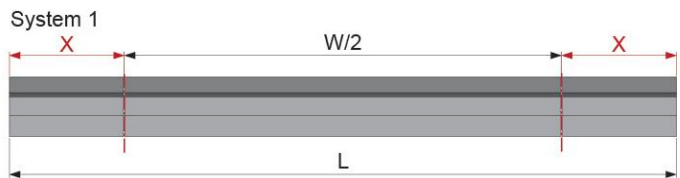

! Please use the cleaning brush to clean the aluminum scraps generated after cutting the track, to keep the inside of the track clean

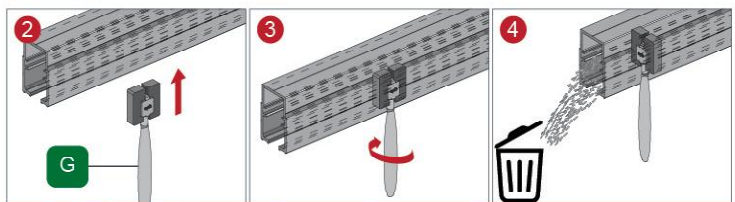

2 Wood Minimal

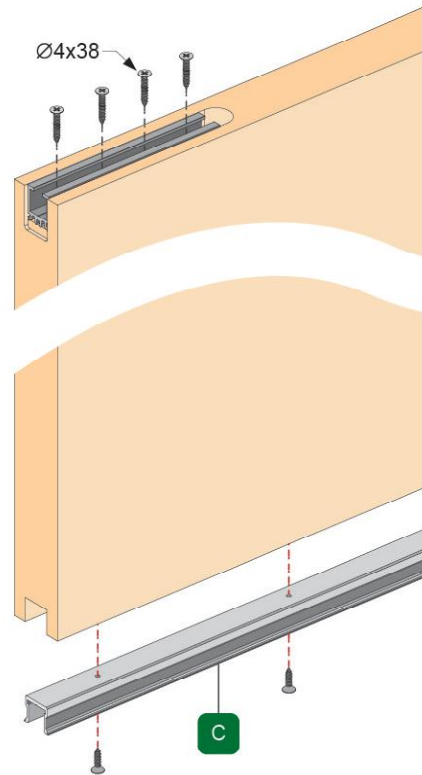
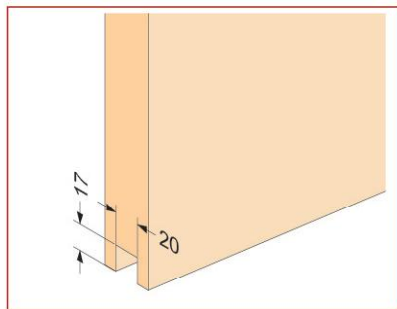
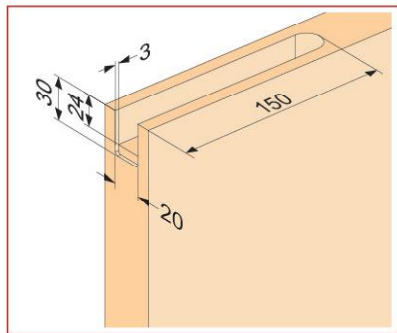

Glass

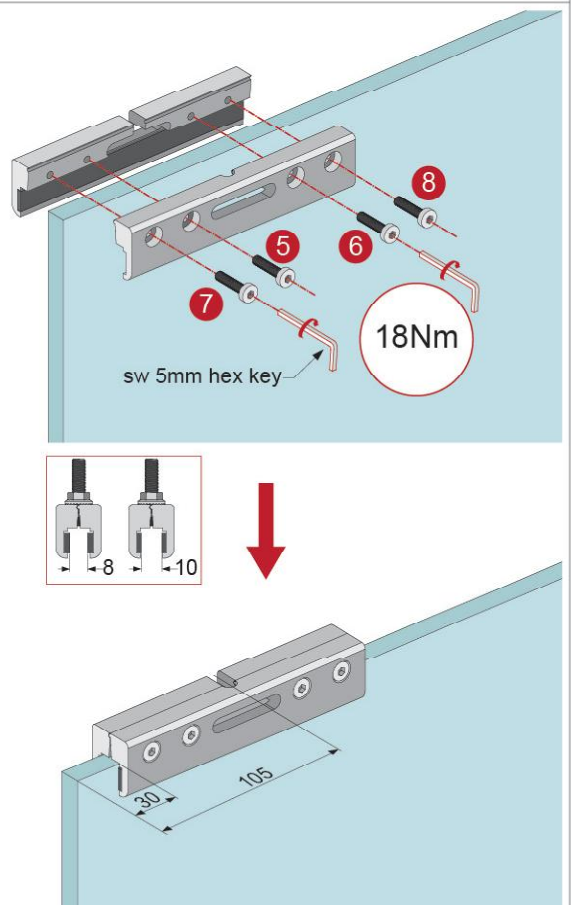
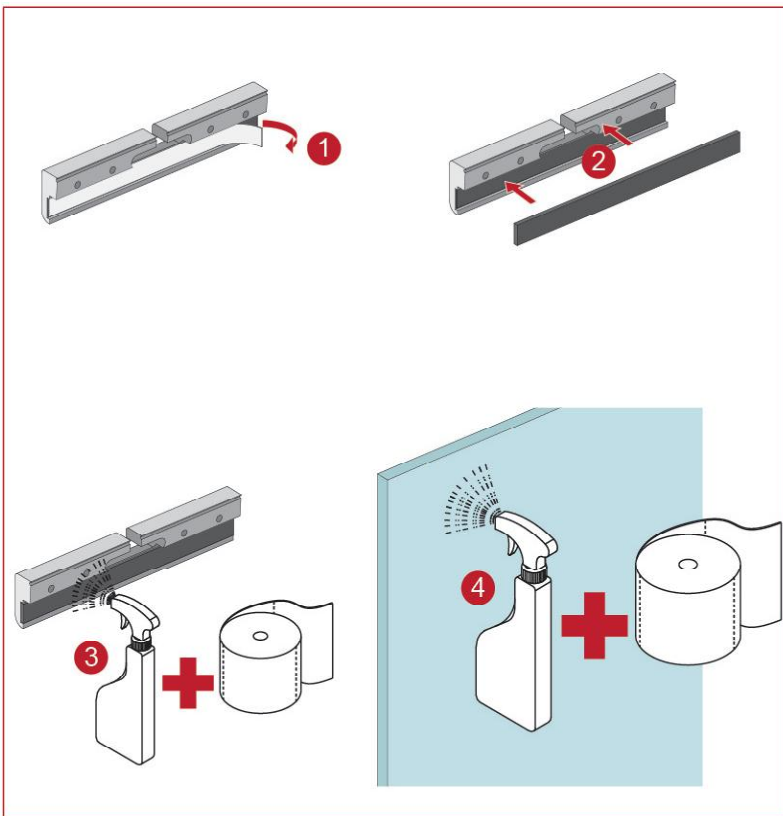

3



Clean the track with a cleaning brush, keep the inside of the track clean

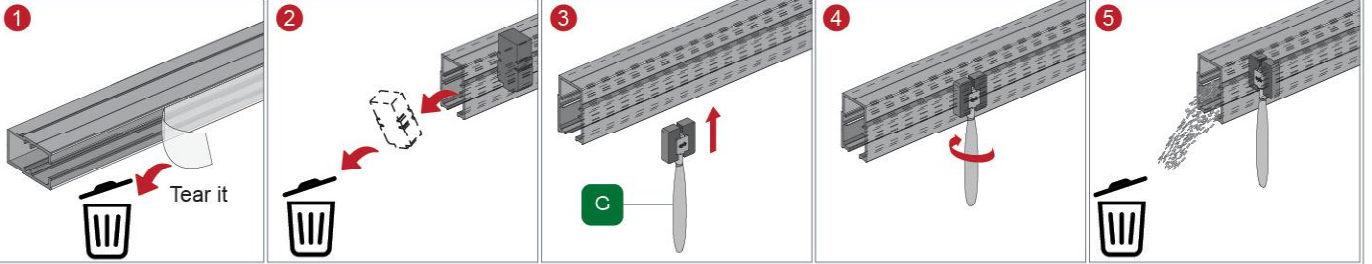

4

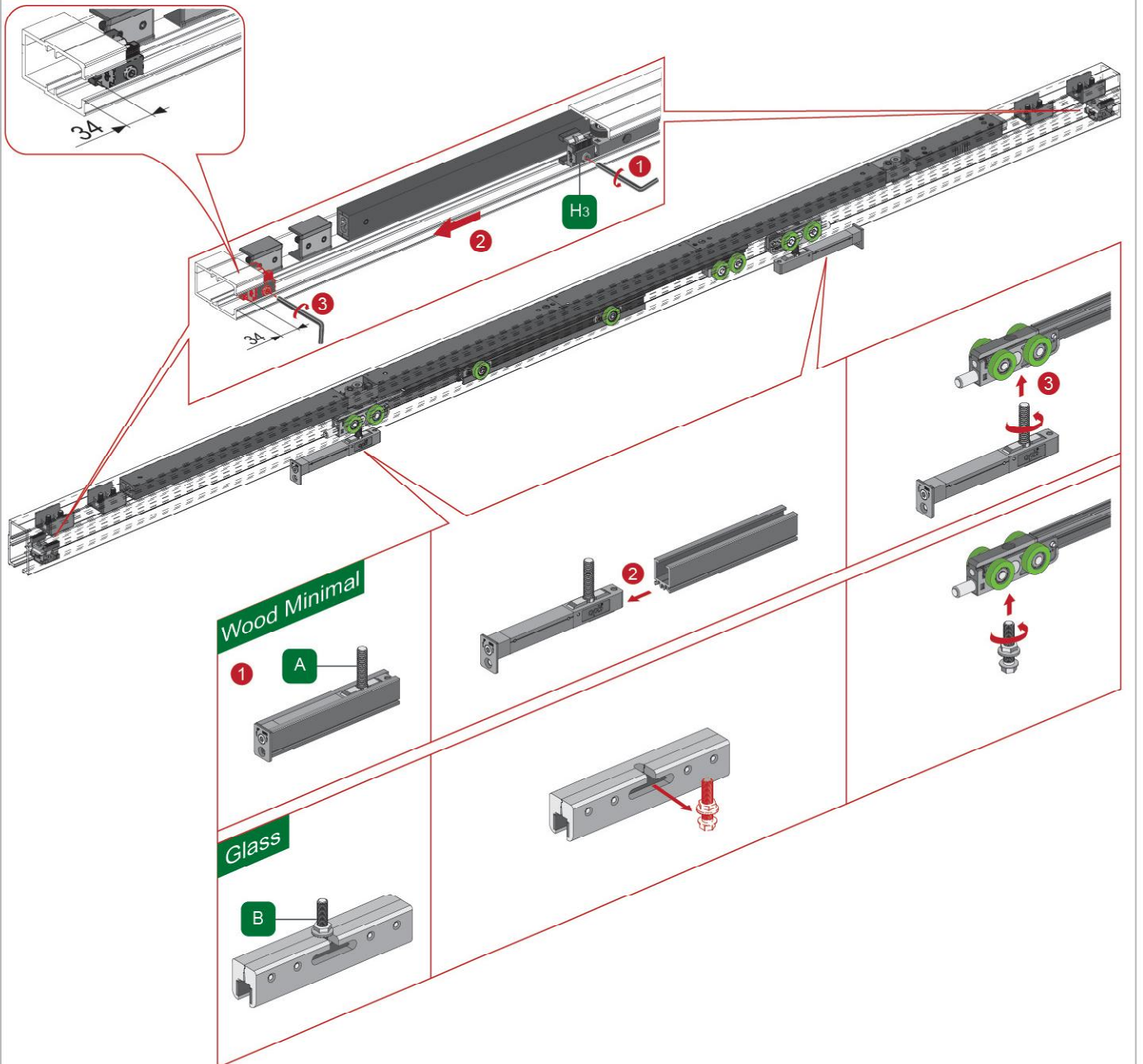

5 Einstellung für eine breitere Tür / Adjustment for a wider door panel

Schienenlänge L Track length L	Lichtes Einbaumaß Door opening size W	Türbreite Door width DW
2000	1400-2000	865~1030
2700	2000-2700	1215~1380
3400	2700-3400	1550~1730

Wood Minimal

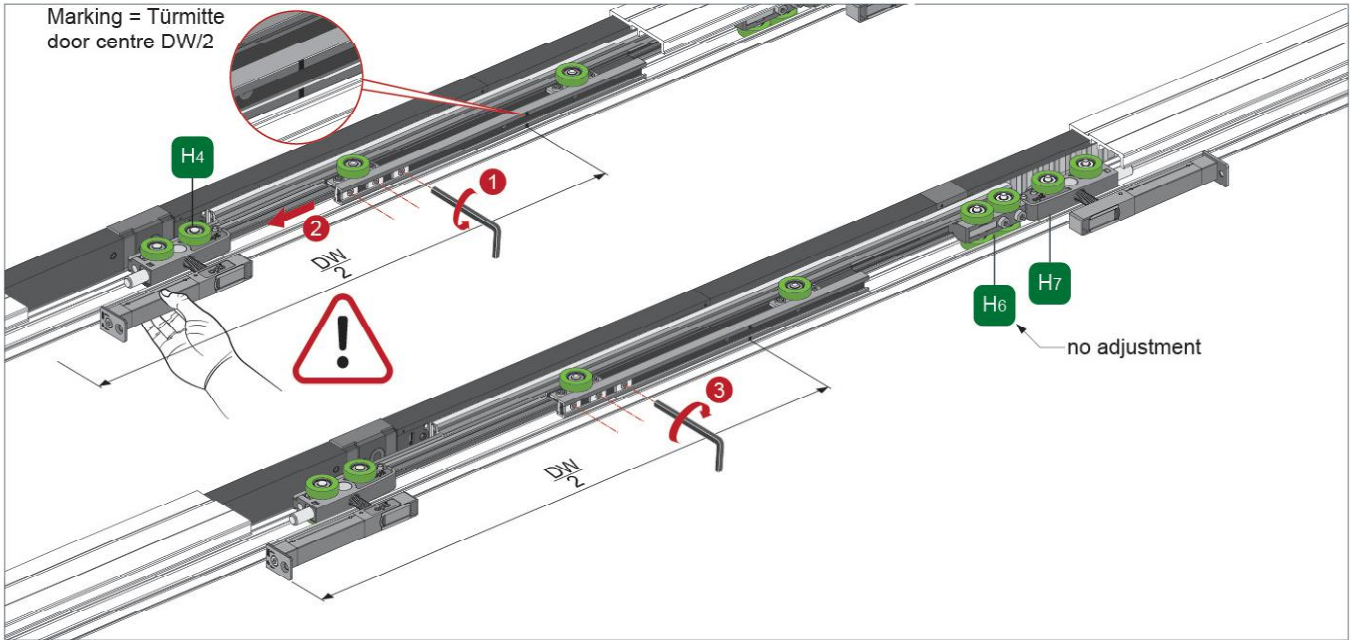
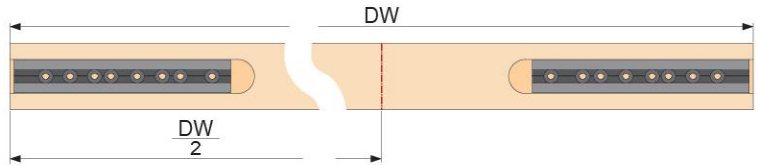

Glass

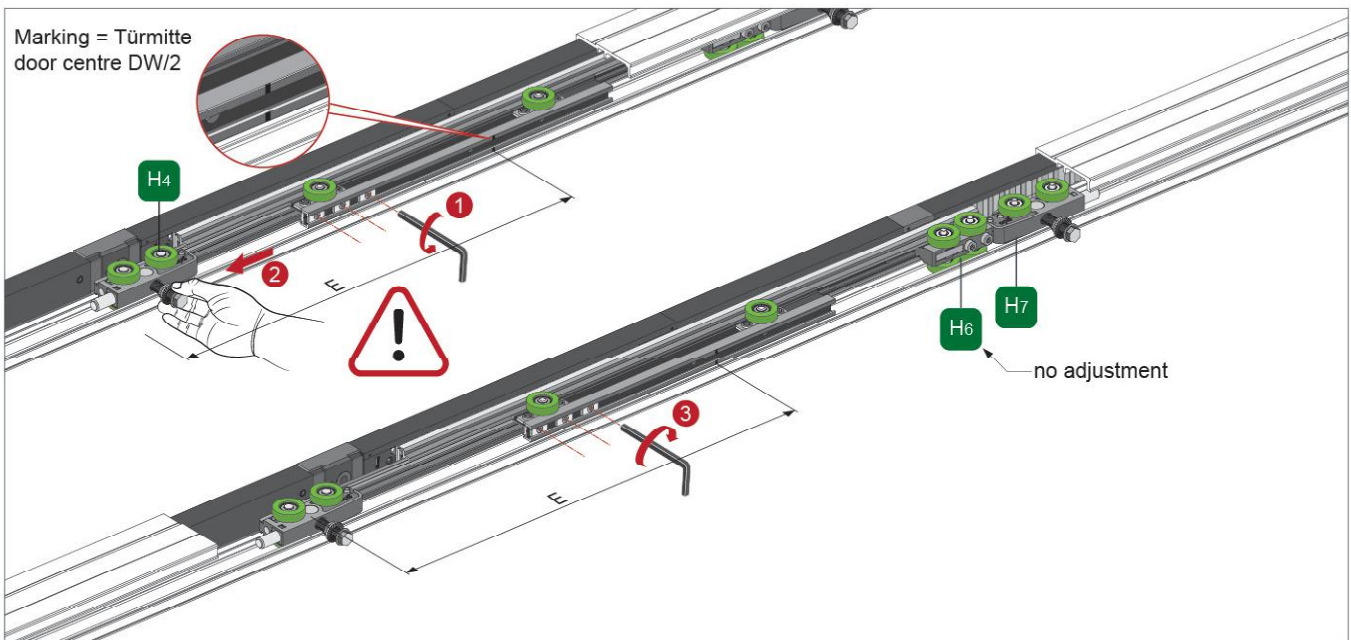
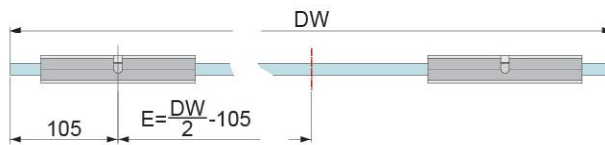

Einstellung für eine schmalere Tür / Adjustment for a narrower door panel

Schiene Länge L Track length L	Lichtes Einbaumaß Door opening size W	Türbreite Door width DW
2000	1400-2000	730~865
2700	2000-2700	1030~1215
3400	2700-3400	1380~1550

Wood Minimal

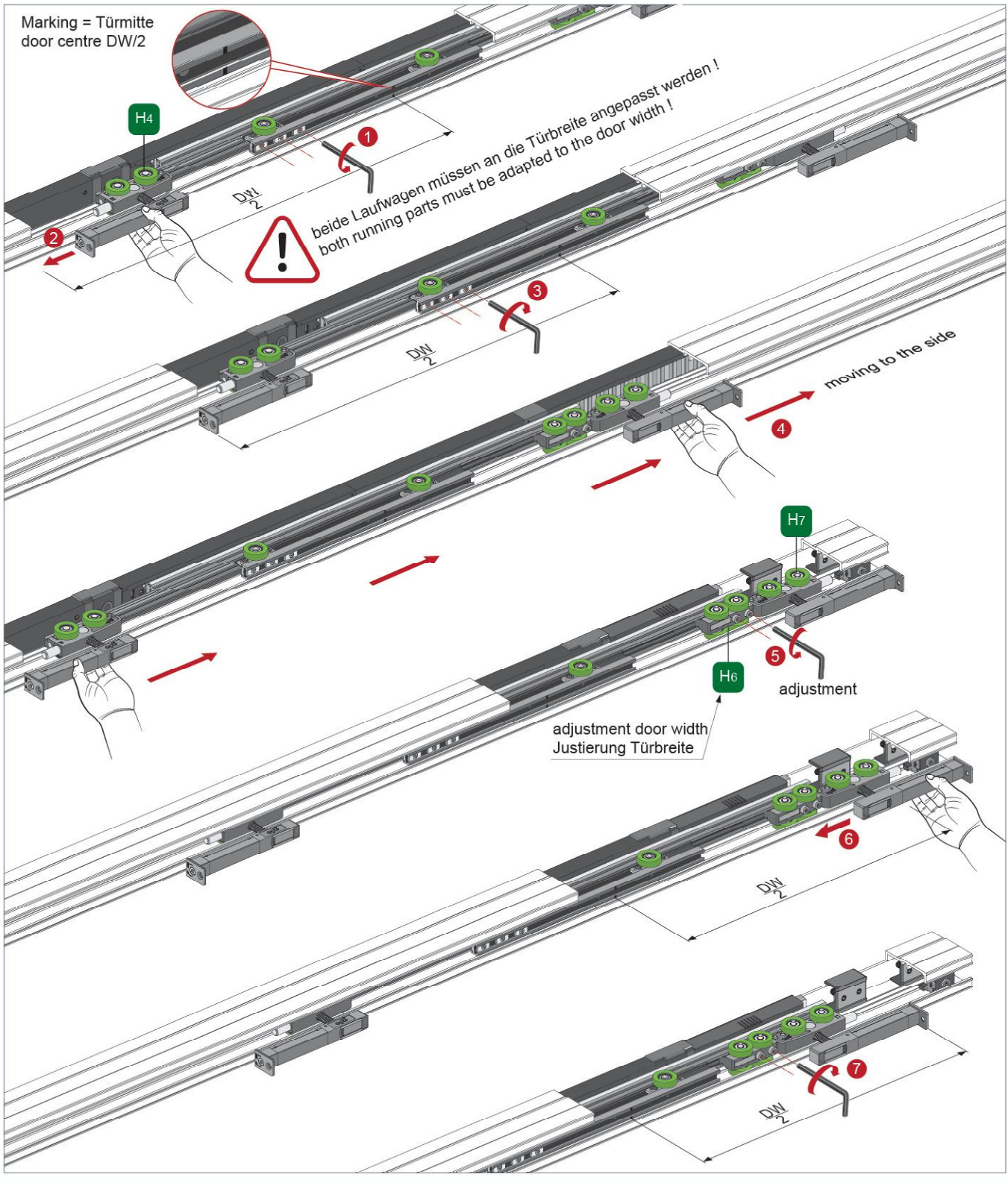
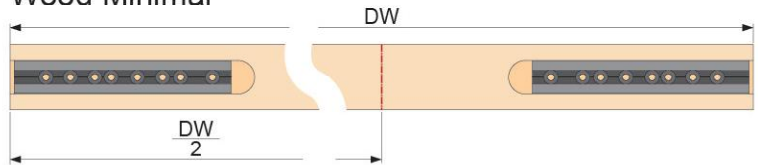

Glass

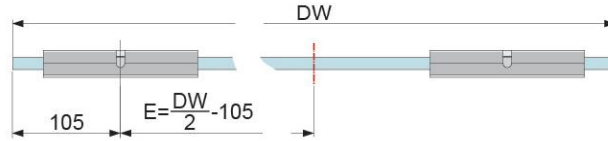

Marking = Türmitte
door centre DW/2

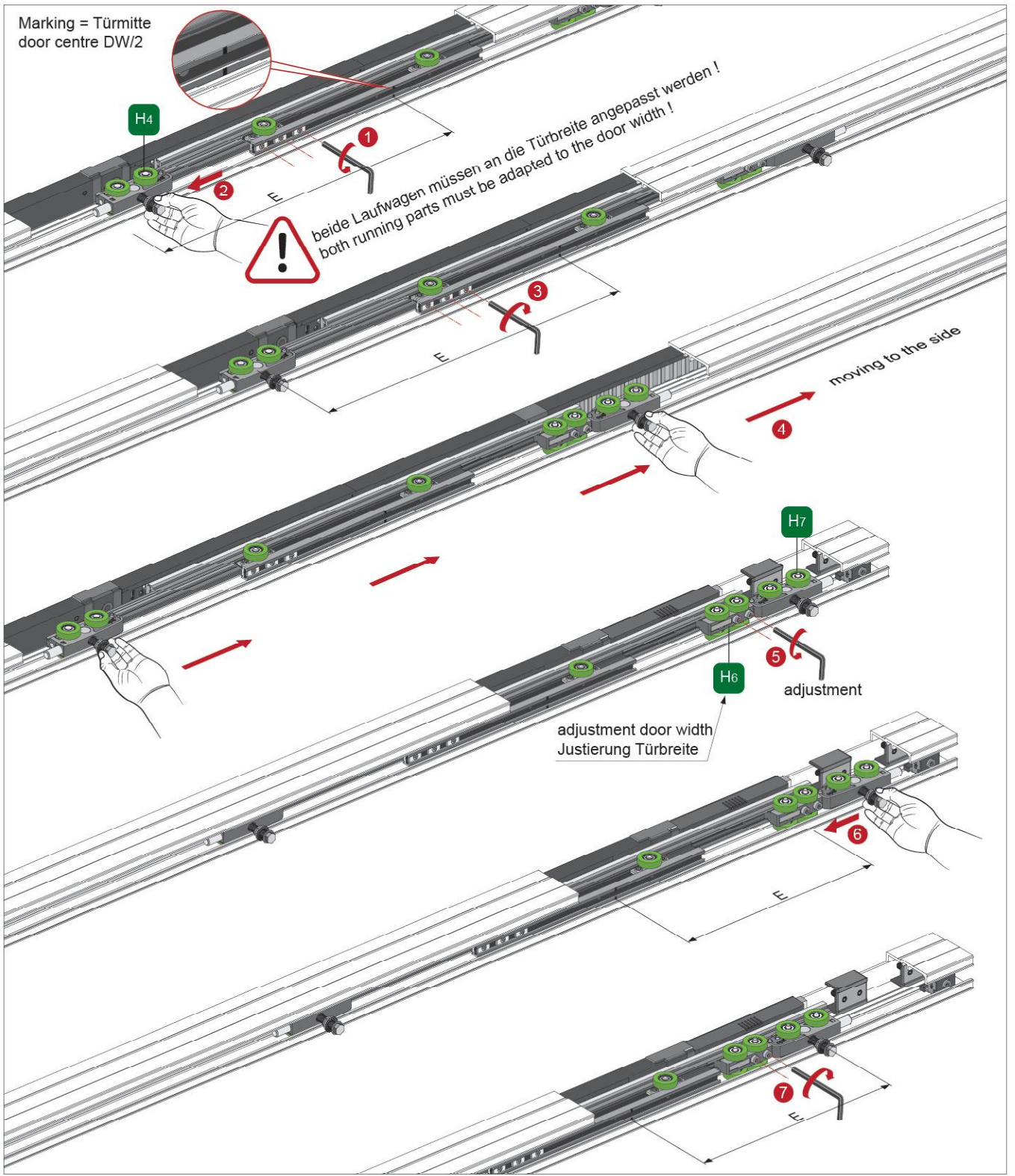

6 Single system / Schiene

bitte achten Sie darauf, dass

- keines der elektrischen Bauteile beschädigt wird
- das Anschlusskabel bei allen Arbeiten an der Schiene vom Stromnetz getrennt ist

Attention

- Do not scratch or break the power cable to avoid electric shock;
- Do not connect the power when installing the product;

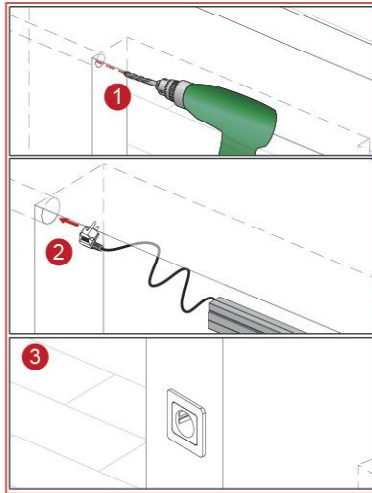

Please reserve the hole for the wire of sensor (Optional)

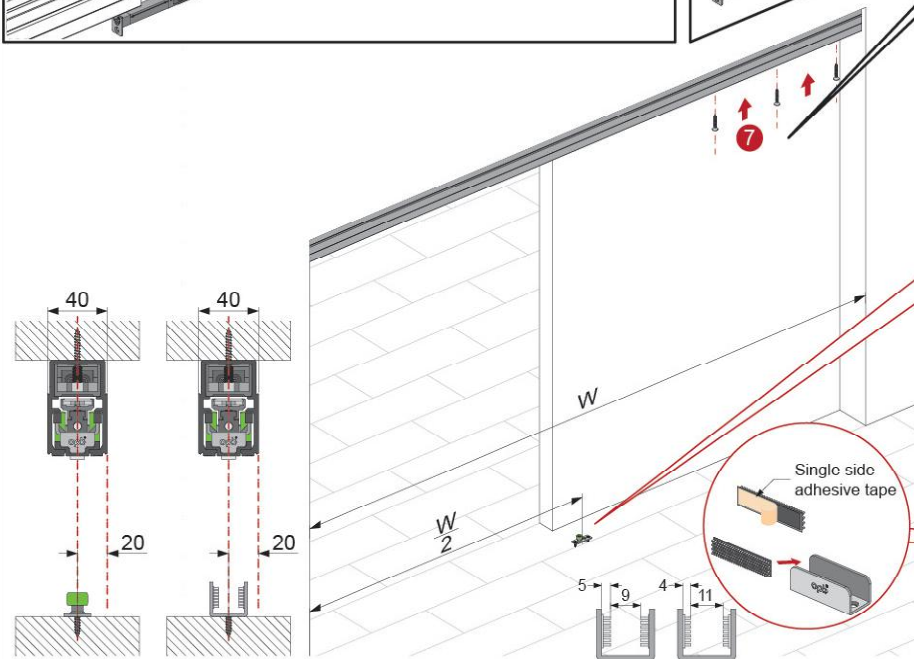
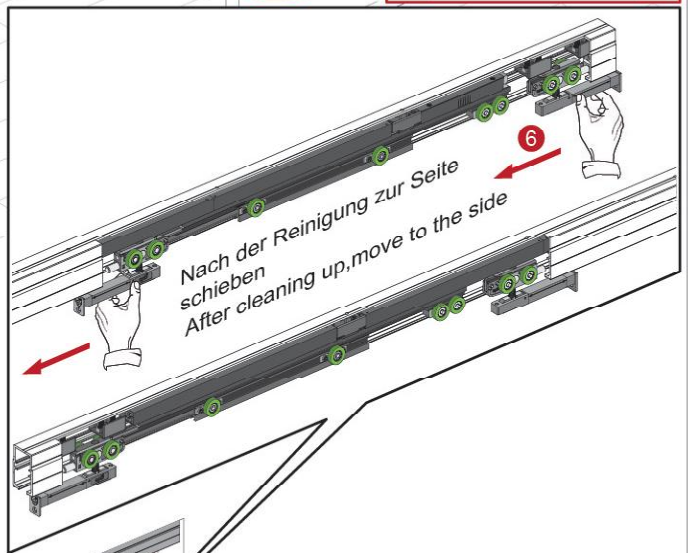
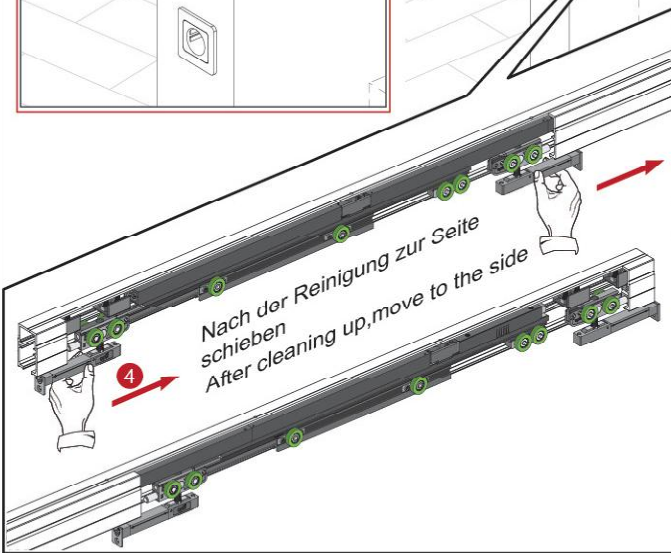
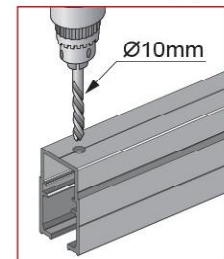

7

Wood Minimal

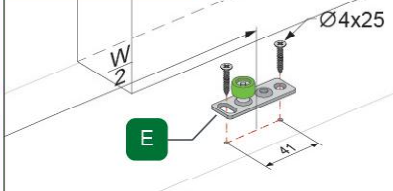

Glass

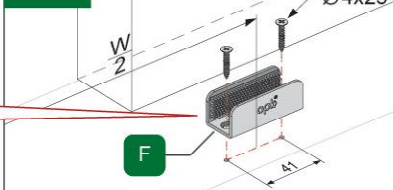

Double systems / Schienen (synchro system)

1 Before installing the track system 1&2, put the booth into the track

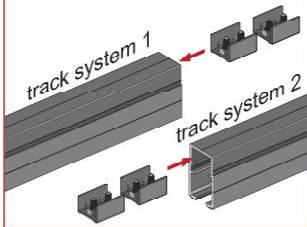

2 Refer to step 6 on page 8 to install track system 1

3 Put one booth to the track connection and fix it.

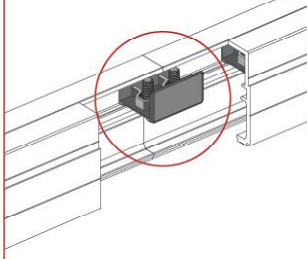

4 Refer to step 6 on page 8 to install track system 2

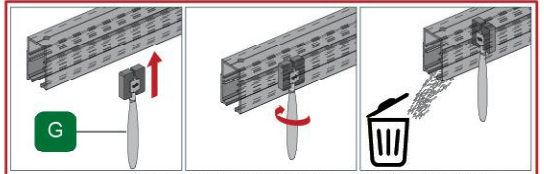

Nach der Schienenmontage bitte die Schiene reinigen, bevor diese in Betrieb genommen wird
After finishing the screw fixing, please clean the track with a cleaning brush to ensure that the inside of the track is clean before the wheel is moved.

Please reserve the hole for the wire of sensor (Optional)

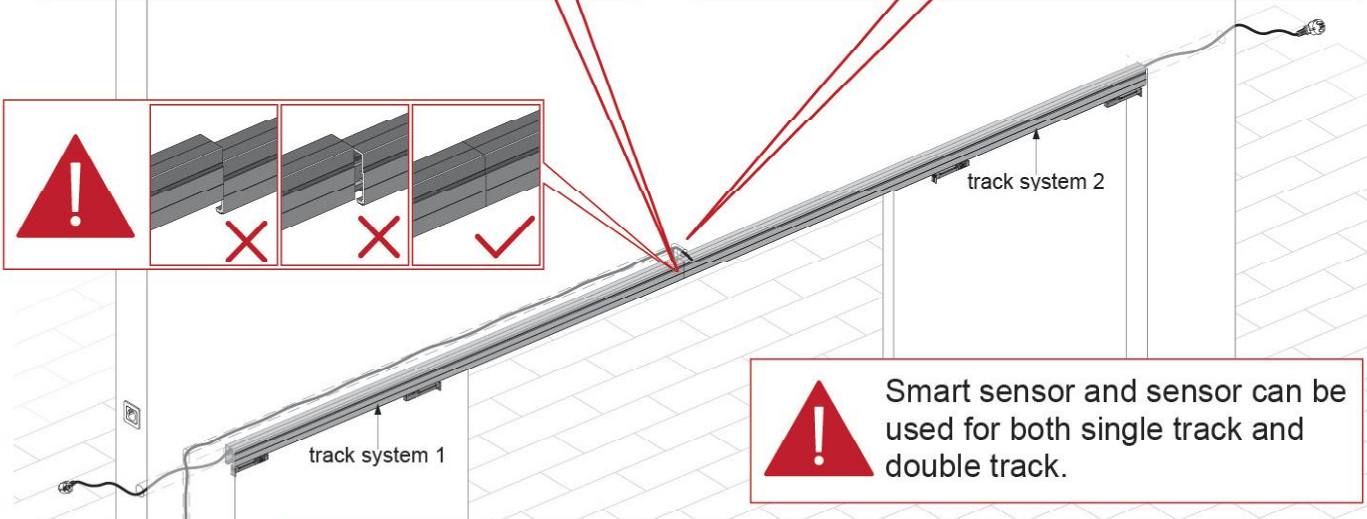
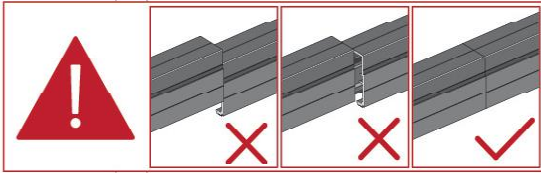
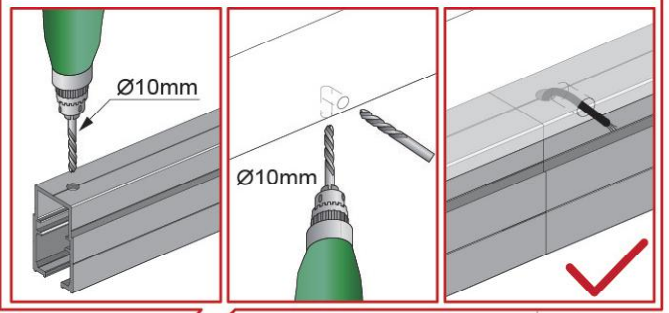

Smart sensor and sensor can be used for both single track and double track.

Please reserve the hole for the wire of the smart sensor (Optional)

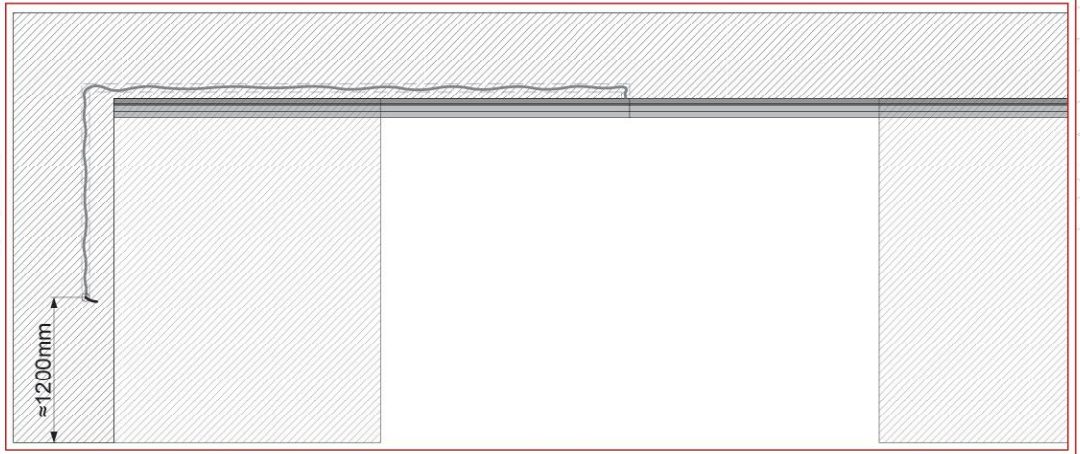

Double systems / Schienen (synchro system)

A

B

Das Synchrokabel bitte unter den Halteklammern führen
If the connecting wire hangs down, please move the booth to keep straight.

3

4

Kabel verbinden mit Rot = "CANH"
Schwarz = "CANL"
Red line connect to "CANH"
Black line connect to "CANL"

5

6

8

40

40

20

20

5

9

4

11

Wood Minimal

Glass

W

$\frac{W}{4}$

$\frac{W}{4}$

$\frac{W}{4}$

$\frac{W}{4}$

Ø4x25

Ø4x25

41

41

Single side adhesive tape

9

Wood Minimal

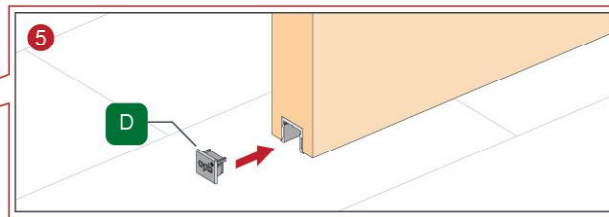
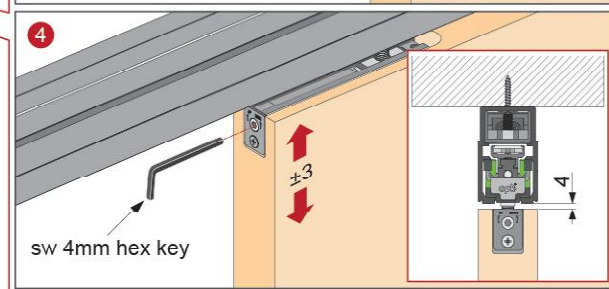
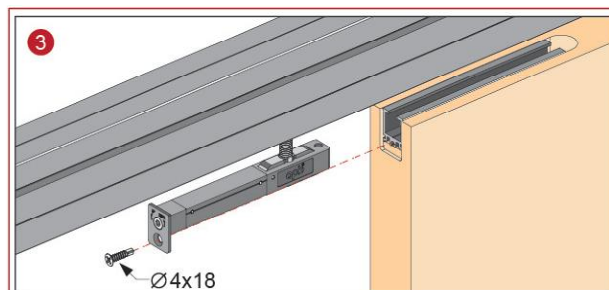
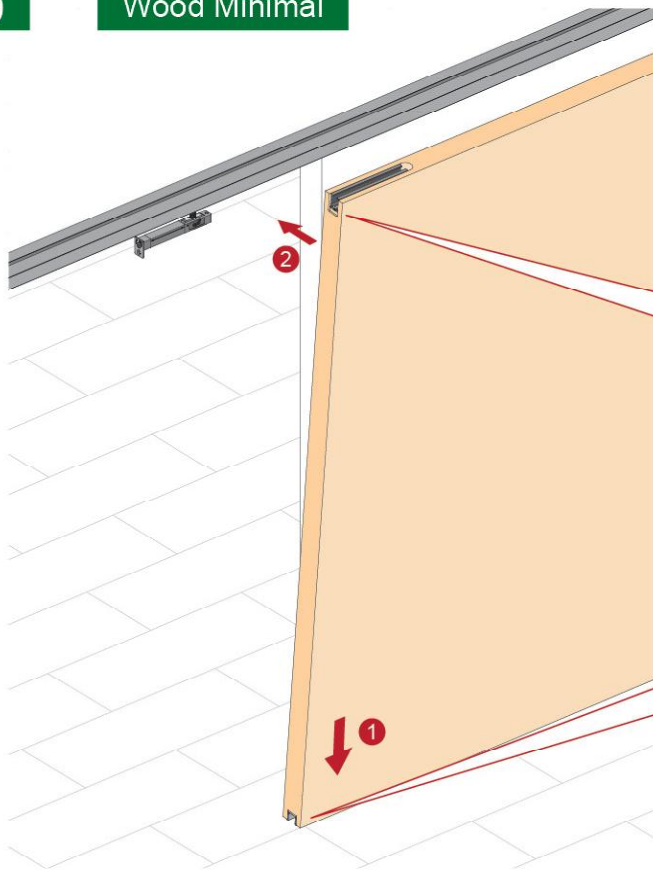

Glass

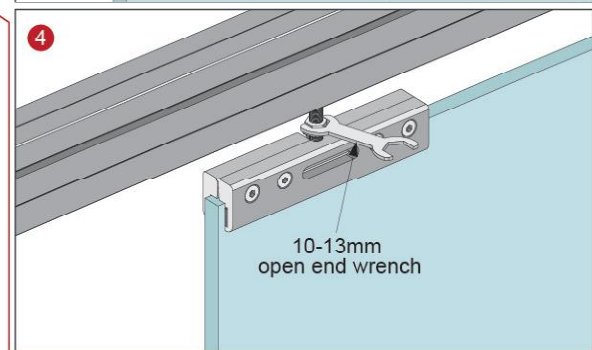
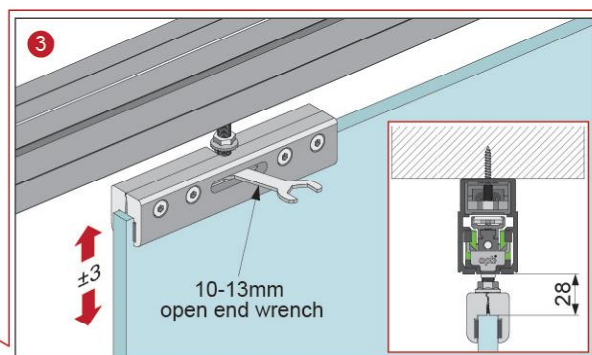
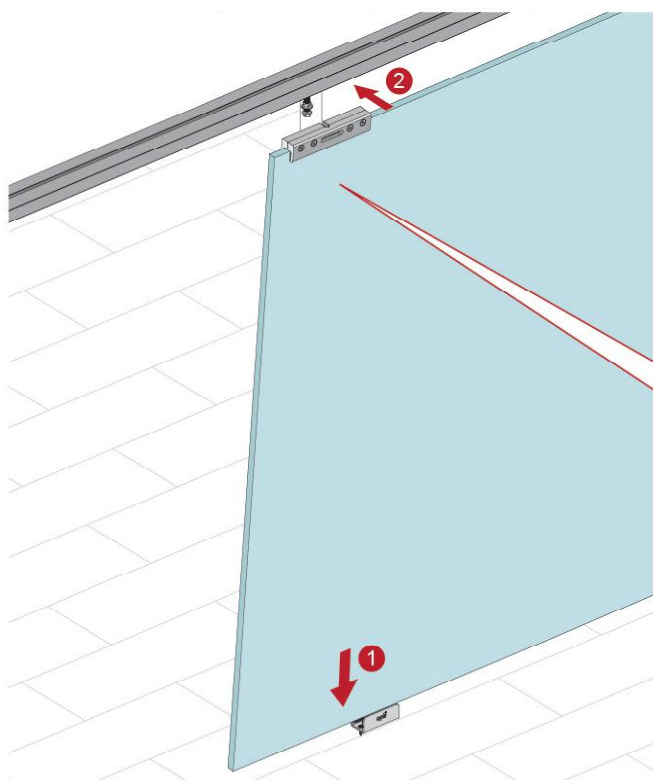

10 Wood Minimal Single system / Schiene



Double systems / Schienen (synchro system)

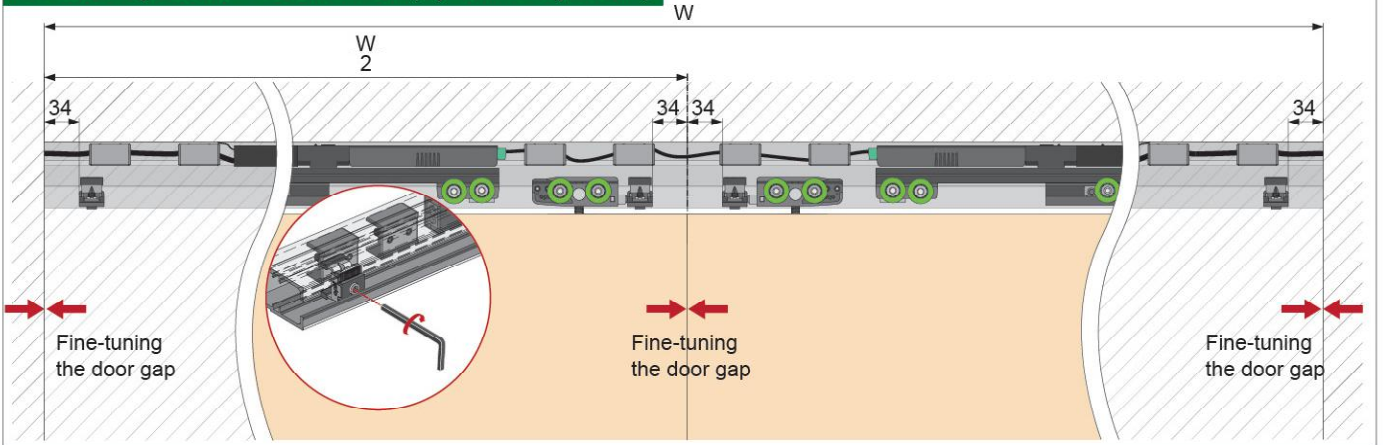

Glass Single system / Schiene

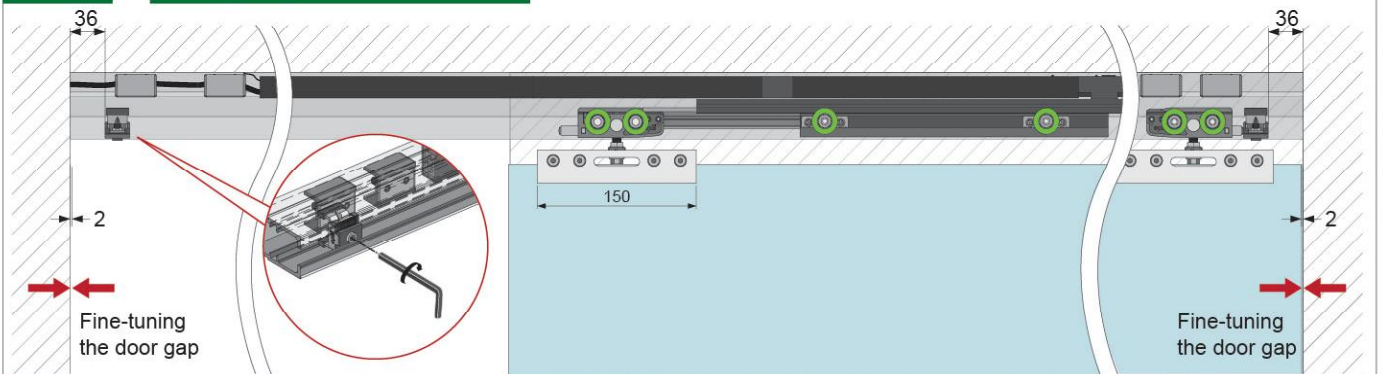

Double systems / Schienen (synchro system)

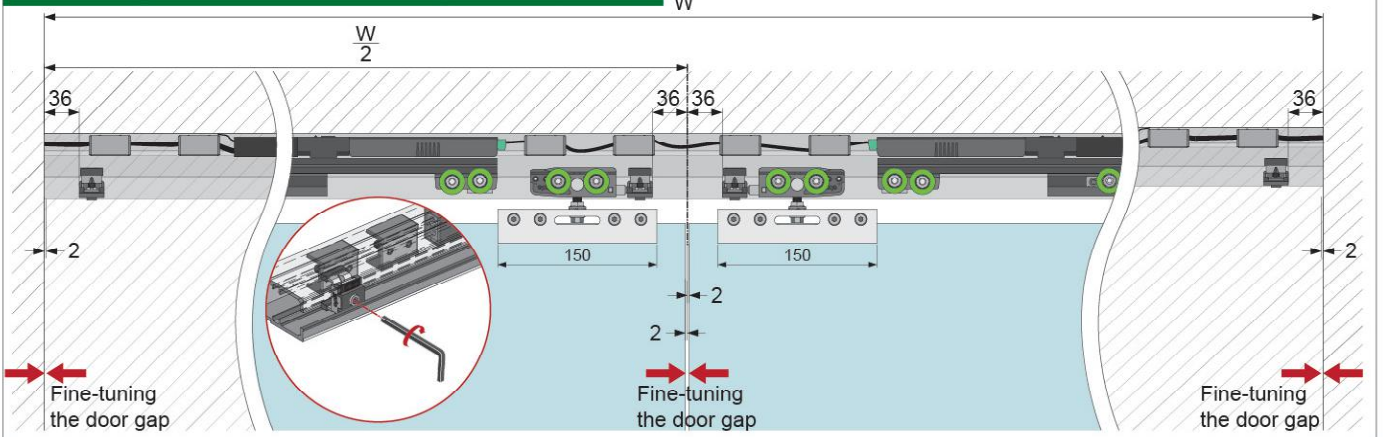

11

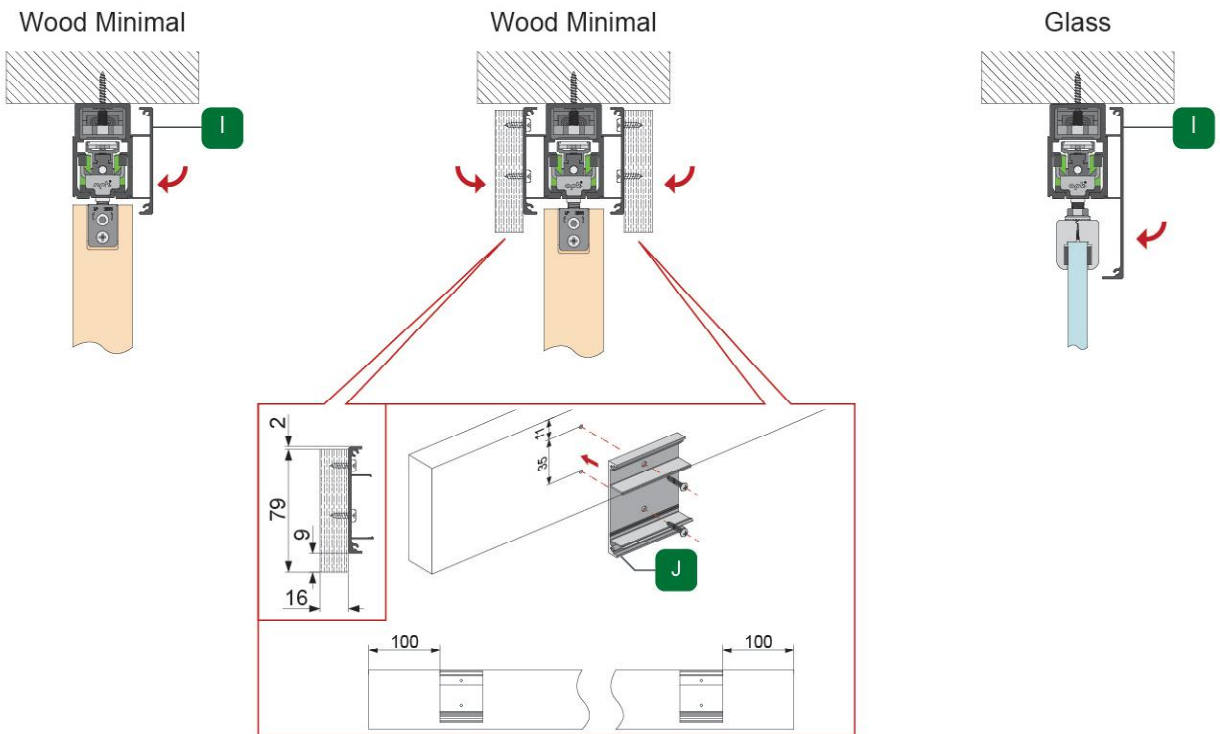

12

Power-on

System self-learning

plug & play, bei Strom an, lernt sich das System selbständig ein

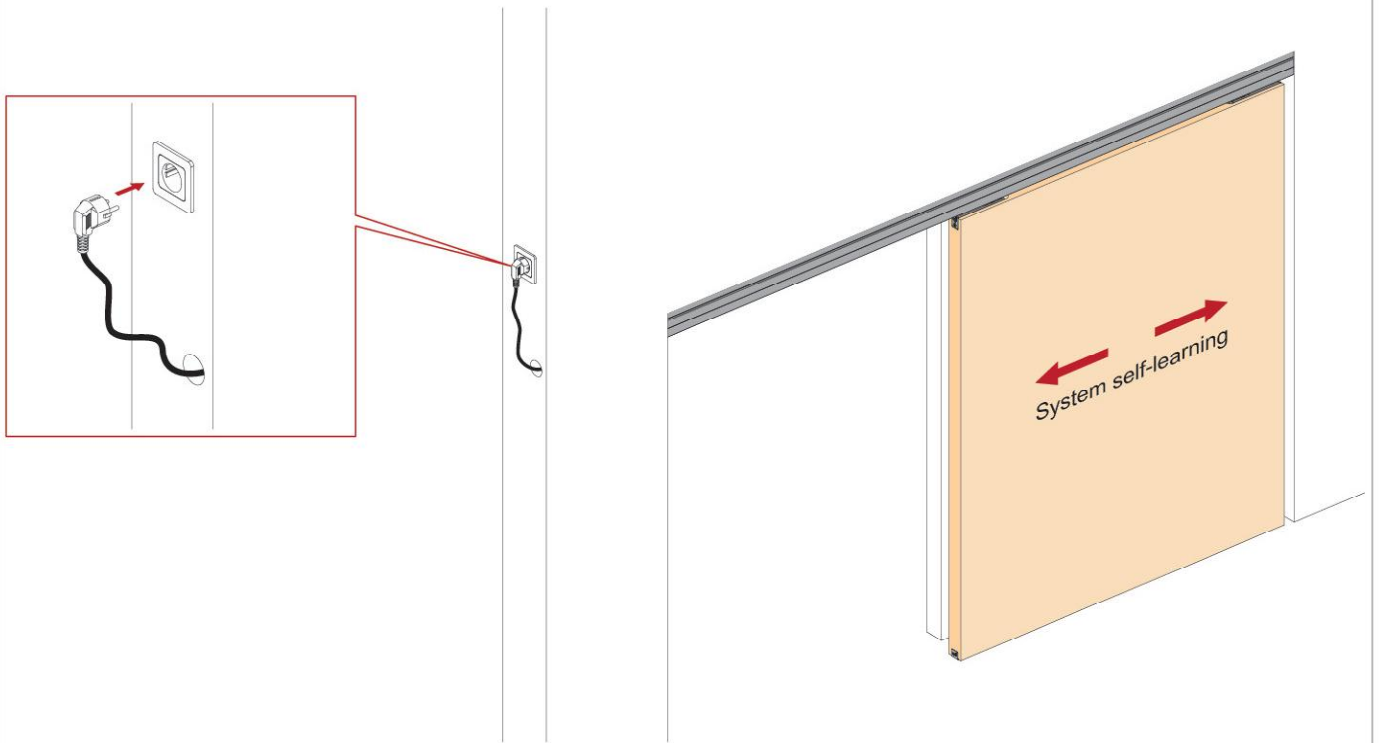

APP application permission activation instructions

Android Type A

If the operation of type A is not suitable for your mobile phone, please operate according to type B

IOS

IOS system searches for "OPK Smart Home" in the App Store

Android

Download the app from Google PlayStore

Download the app for iOS + android from website:
www.opkeurope.com

01. Open the status bar and confirm that "Location Information" is turned on

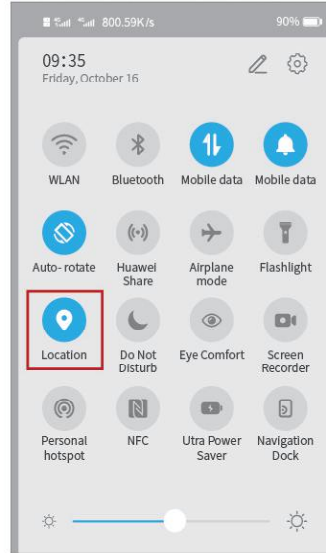

02. Click "Settings" icon

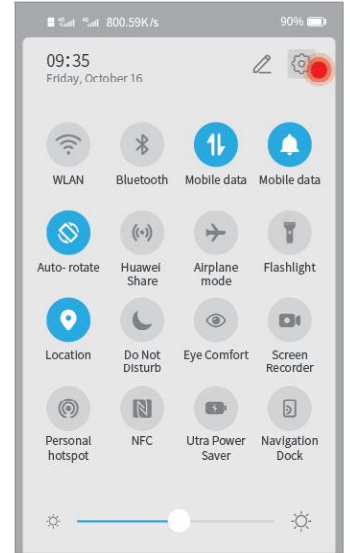

03. Select "Apps"

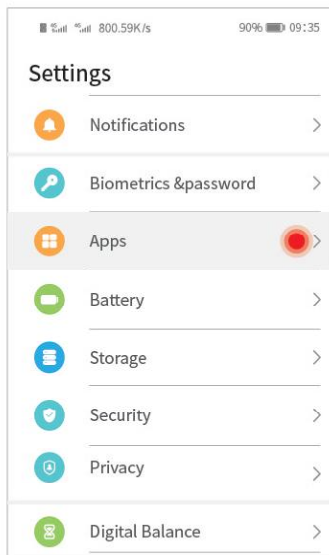

04. Select "Permission manager"

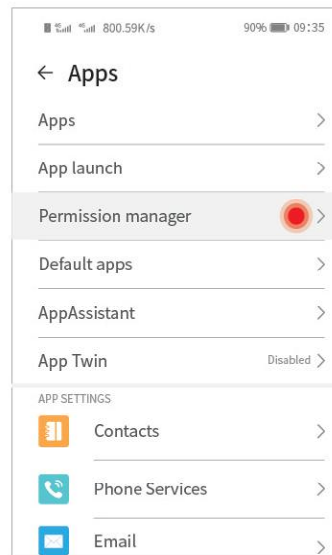

05. Search "OPK" and click on the APP icon

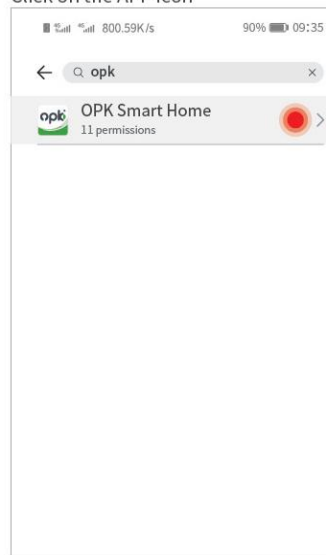

06. Select "Storage"

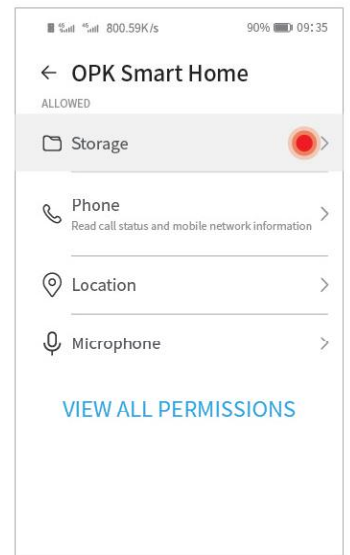

07. Click "Allow"

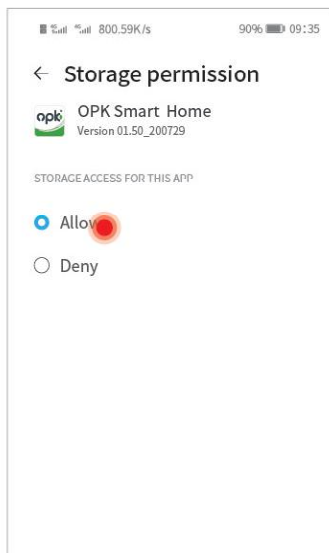

08. Click "Return" icon

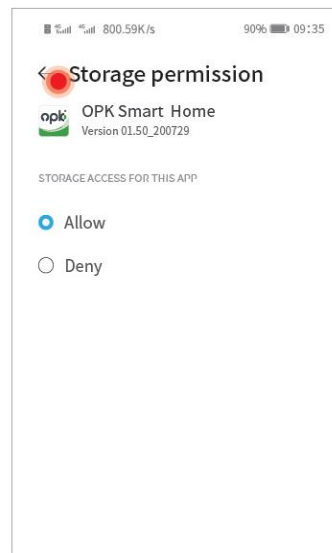

09. Select "Location"

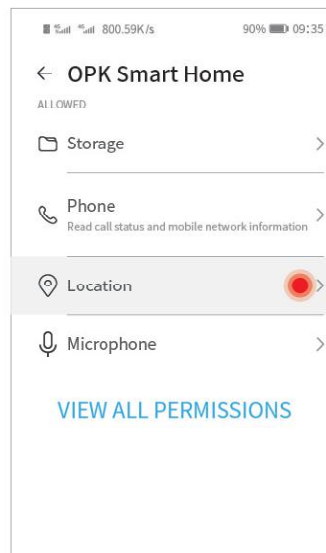

10. Select "Allow all the time"

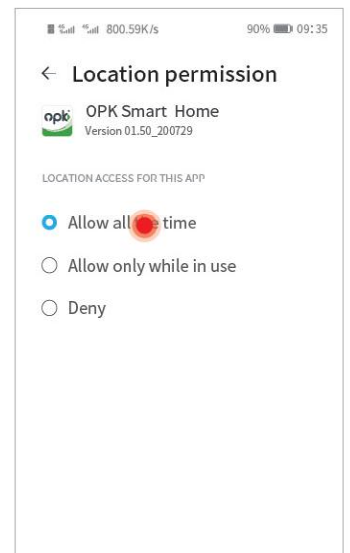

Android Type B

01. Click Settings

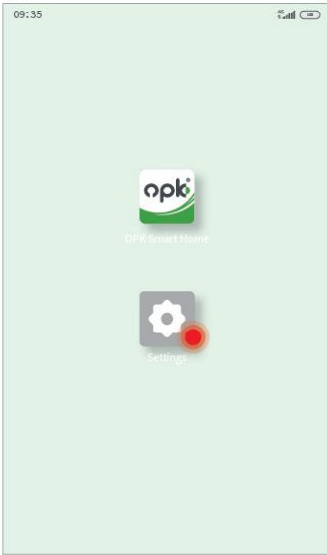

02. Select "Apps"

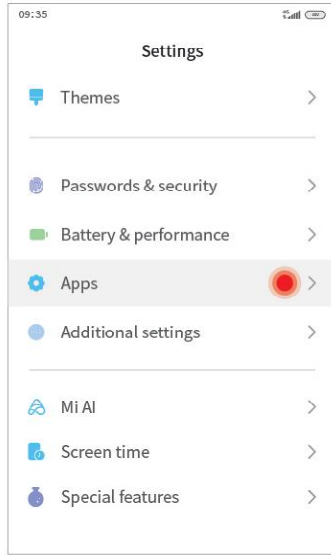

03. Select "Permissions"

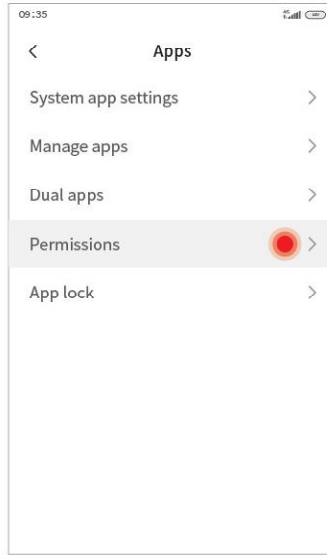

04. Select "Permissions"

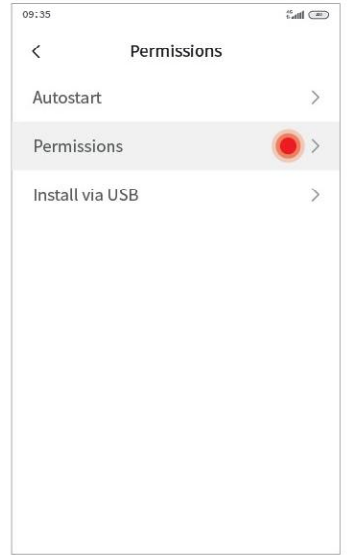

05. Search "OPK" Click on the APP icon

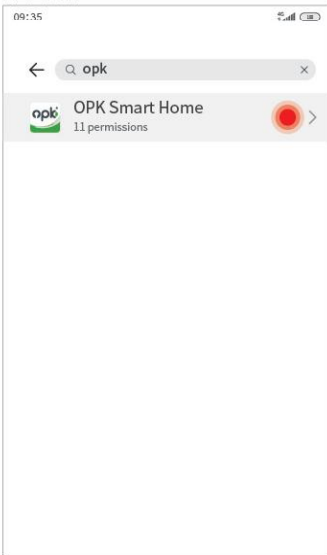

06. Set all permissions options to "Allow"

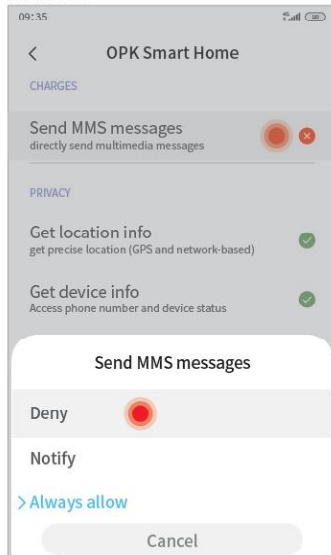

07. Confirm that all permission icons are "✓"

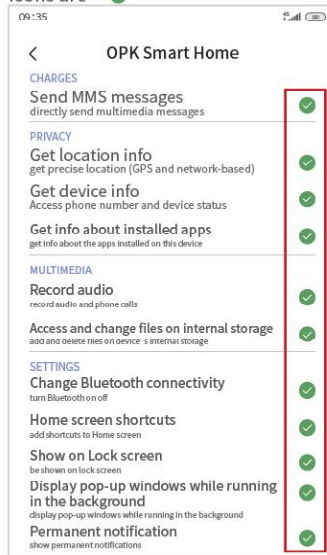

Features Power on and learning

Single system

Einschalten Turn on the power



Automatically the system detects the door opening width when power is turned on.

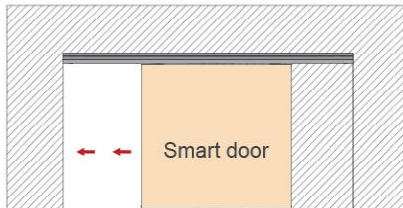

The door is stopped and the inspection is completed.



Double systems

Einschalten Turn on the power

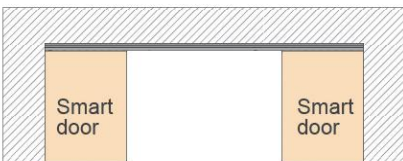

Automatically the system detects the door opening width when power is turned on.

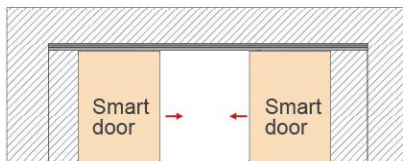

The door is stopped and the inspection is completed.

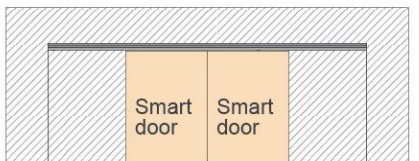

Use app to learn the door weight after self-learning the system door opening width.

01. Open the app

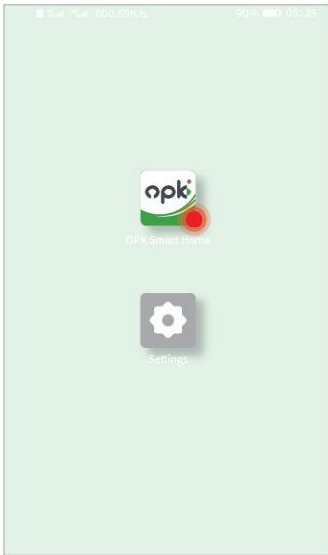

02. Click optional position

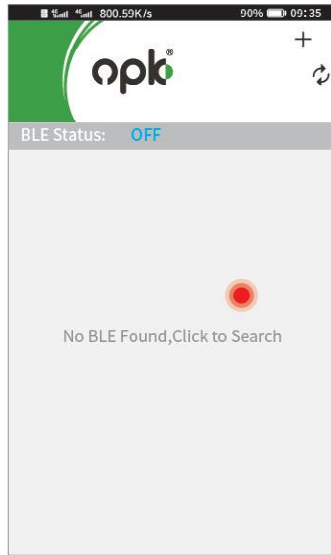

03. Turn on the bluetooth

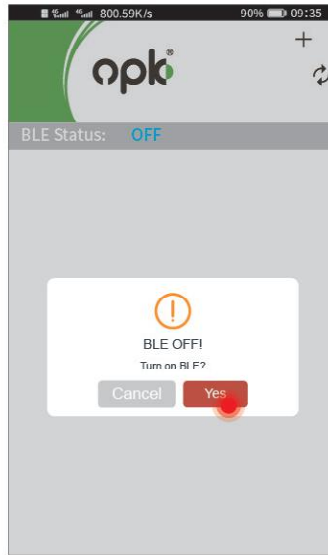

04. Click OK. Begin to search the equipment

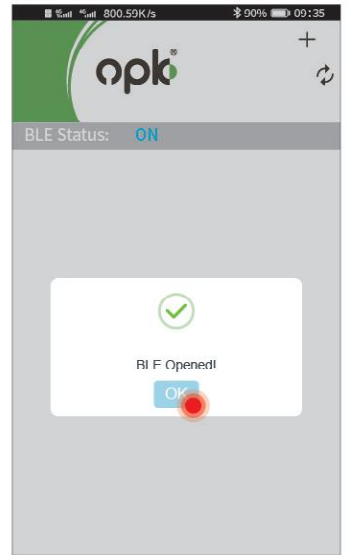

05. Find device

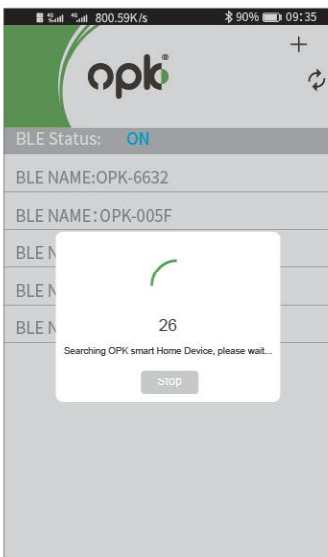

06. Click on the device, select the corresponding device name to connect

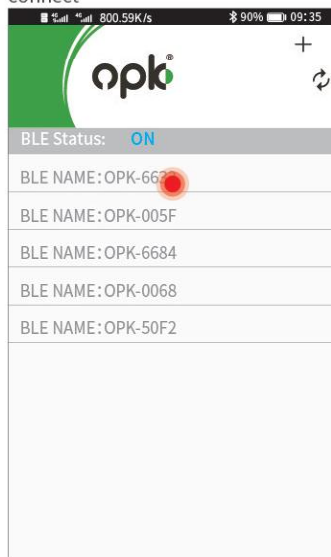

07. Device connecting

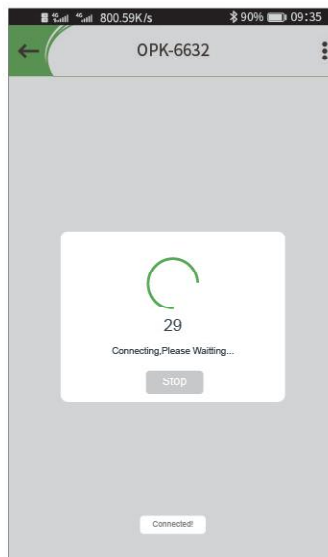

08. Click the signal at the top right

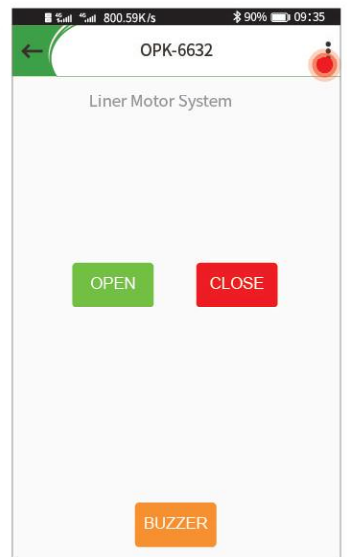

09. Open the operating parameters adjustment

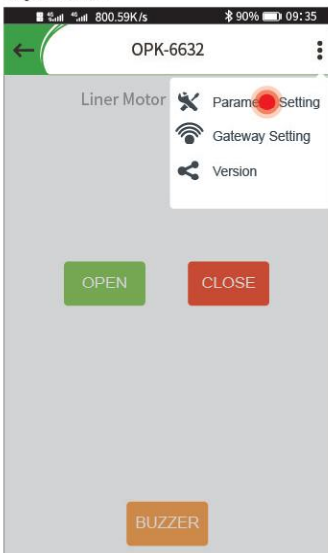

10. Click the "SELF-STUDY" button, the system starts to detect the door weight

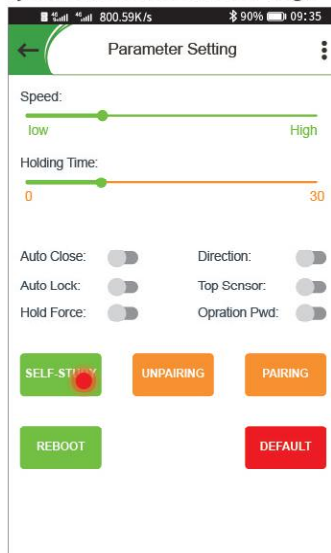

11. Test whether the direction of the door panel is correct

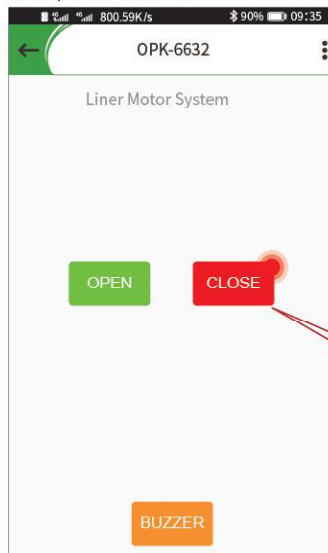

After clicking close, if the direction of the door panel is not correct, please see the operation on page 18

Introduction to operating parameters

Adjust the speed of door panel walking

Adjust the staying time after the door panel is opened (only when the automatic door closes in the open state)

OFF: Single door open or close
ON: Door close automatically

ON: The door can be automatically locked (OPK electromagnetic lock must be used), in this case, the "Sensing" function does not work any more

Maintain the strength of the closing

Door panel operation learning

Restart the system

Clear the device code in the system

Solve the abnormal movement direction of the door panel (please see the operation on page 18)

After installing the top sensor, open or close the top sensor

After opening, set a password of more than 8 digits (When a password is set, all mobile phones must enter the password for each operation to issue instructions)

Remote control code

Click the button and enter the password 666666 to restore the factory settings

Product Name: Smart Sliding Door System

Rated voltage	200 ~ 240V / 50Hz	Rated power	70W
Standby power	5W	ISM frequency	433.92MHz
Bluetooth frequency	2402 ~ 2480MHz	Door opening speed	Min 0.065M/S Max 0.26M/S
Control mode	Microcomputer controller	Collision function	Rebound when blocked or collided conditions
Manual opening and closing force during power off	E-Space ≤ 10N	Temperature range	-20 ~ 40 °C

Einstellung und Korrektur des Synchrosystems How to solve the abnormal moving direction of the door panel of the synchro system

Wenn nur eine Tür bei 'close' in die Schliessposition fährt, die Schaltfläche 'direction' drücken, ein Signal ertönt. An der offenen Tür ziehen, der Signalton bestätigt sich und beide Türen schliessen gemeinsam.

Case 1: After clicking the "CLOSE" button, there is a door that is not in the middle

Solution:

Click the "Direction" button, the track emits a continuous sound of "Didi Di...", pull the wrong door panel, the door panel starts to walk, and the sound stops, the door panel direction change completed

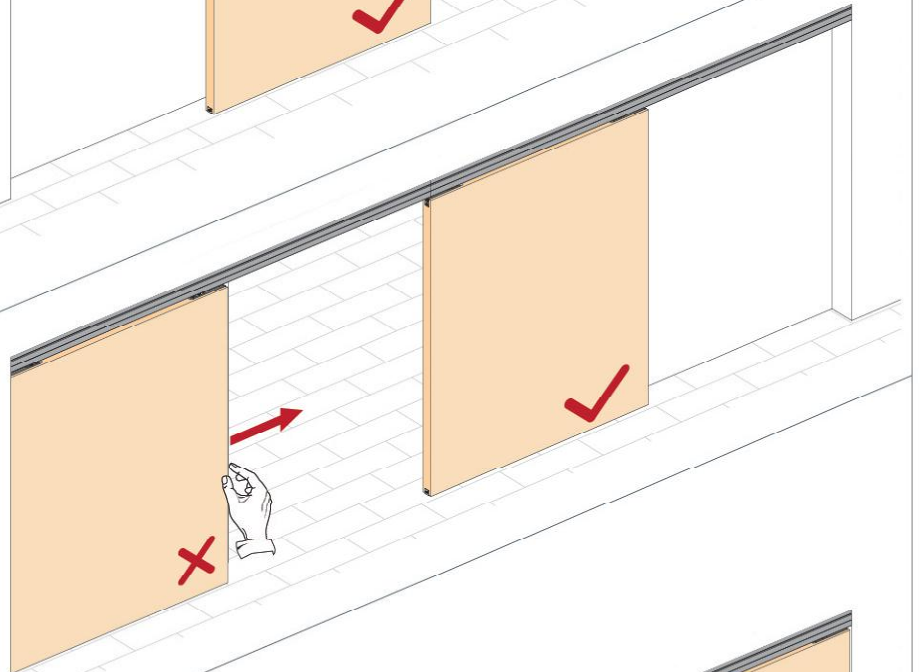
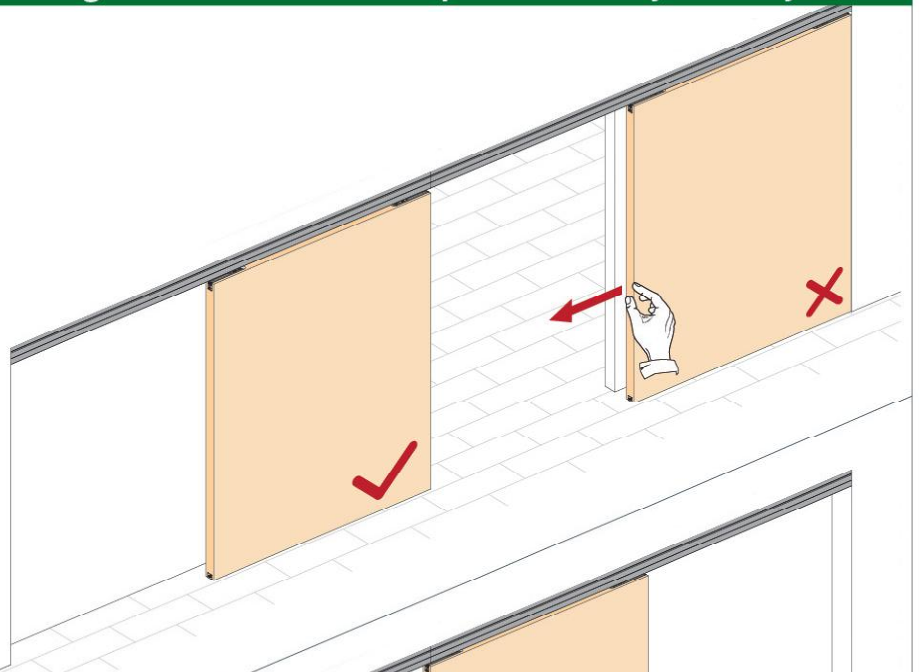
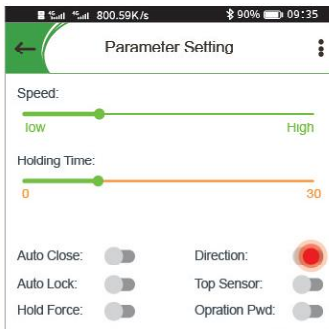
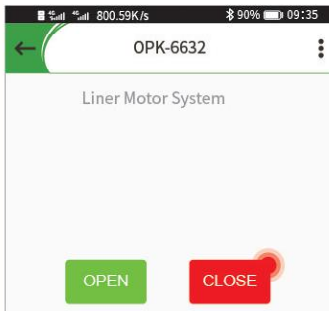

Wenn die Richtung schliessen / öffnen vertauscht ist:

Schaltfläche 'Richtung' / 'Direction' drücken, ziehen Sie an der linken Tür und diese bewegt sich. Wenn der Signalton erlischt, ist die Richtung geändert. Ebenso bei der rechten Tür.

When the "OPEN" or "CLOSE" button on the APP control door is opposite to the actual door movement direction.

How to solve:

Click the "Direction" button, track system will have a continuous sounds like "Dididi". Then pull the left door, and the door starts walking, when the sound stops and the direction change of the door is completed. The right door repeats this operation.

