

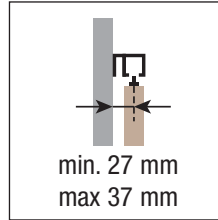

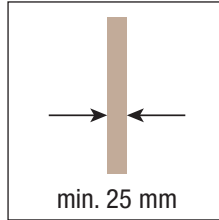

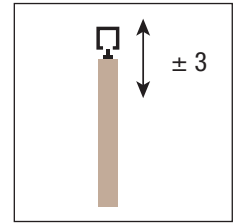

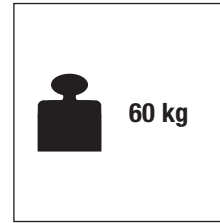
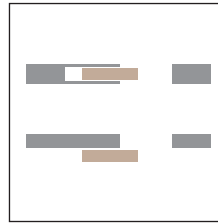
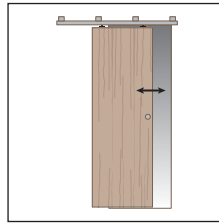
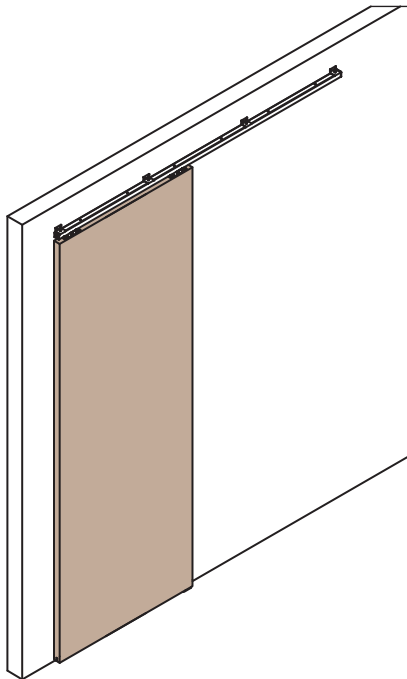

SYSTEM 0500/60

Schiebetürsystem für Holztüren
Sliding system for wooden doors
 Schuifstelsysteem voor houten deuren







Patentiert
 Patented
 Gepatenteerd









KIT Art. 0500 2

Laufwerk Tragkraft 60kg <i>Upper roller 60kg</i> Bovenste rol 60 kg		2 pcs
Befestigungslasche Laufwerk <i>Double hooking door bracket</i> Bevestigingssteun loopwerk		2 pcs
Tragschraube <i>Support screw for roller (hanger)</i> Ophangschroef met bevestiging en instelmoer		2 pcs
Einstellbare Bodenführung <i>Adjustable lower guide</i> Verstelbare vloergeleiding		1 pcs
Fangstopper <i>Stop brake</i> Rem		2 pcs
Inbusschlüssel <i>Valve seat wrench</i> Inbusleutel		1 pcs
Gabelschlüssel <i>Fork wrench</i> Inbusleutel		1 pcs

*Ersatzteile - *Spare parts - *Reserveonderdelen

Art. 0500 51 Laufwerk Tragkraft 60kg <i>Upper roller 60kg</i> Bovenste rol 60 kg		2 pcs
Art. 0500 55 Befestigungslasche Laufwerk <i>Double hooking door bracket</i> Bevestigingssteun loopwerk		2 pcs
Art. 0500 54 Tragschraube <i>Support screw for roller (hanger)</i> Ophangschroef met bevestiging en instelmoer		2 pcs
Art. 0500 13 Einstellbare Bodenführung <i>Adjustable lower guide</i> Verstelbare vloergeleiding		20 pcs
Art. 0500 12 Fangstopper <i>Stop brake</i> Rem		2 pcs
Art. 0500 58 Fixierplatten + Schrauben für Wandbefestigungsprofil 0500 F <i>Fixing plates + screws for 0500 F hooking profile to a wall</i> Bevestigingsplaten + schroeven voor 0500 F hoekprofiel aan een wand		100 pcs

Passende Zubehöre Compatible accessories Bijpassende accessoires

Art. 0500 1	m 6	
Art. 0500 180	m 1,8	
Art. 0500 200	m 2	
Art. 0500 240	m 2,4	
Art. 0500 300	m 3	
Art. 0500 400	m 4	
Alu-Laufschiene, gebohrt Tragkraft 60/80 kg, silbereloxiert (F1) <i>Drilled and anodised aluminium track 60/80kg</i> Geperforeerde rail van geanodiseerd aluminium 60/80kg		
Art. 0500 4		
Wandbefestigungswinkel 60/80kg <i>Side mount 60/80 kg</i> Zijdelingse steun 60/80kg		
**Art. 0500 F 200	m 2	
**Art. 0500 F 300	m 3	
**Art. 0500 F 400	m 4	
Wandbefestigung 60/80kg <i>Wall fixing 60/80 kg</i> Wandbevestiging 60/80 kg		
**Art. 0500 M 200	m 2	
**Art. 0500 M 300	m 3	
**Art. 0500 M 400	m 4	
Alublende für Mitteldeckung <i>Rib middle covering</i> Afdekkapje		
Art. 0500 61		
Endkappen Alu-Laufschiene <i>Side closing rail</i> Zijdelingse sluiting rail		
		10 pcs
Art. 0500 63		
Endkappen für Mitteldeckung <i>Side closing rib middle</i> Zijdelingse sluiting midden profiellijst		
		5+5 pcs

*Die Artikel in der Tabelle "Ersatzteile" können **nur** in den angegebenen Mengen bestellt werden.

**Nicht kompatibel mit den Artikeln 0500 4.

*The articles in the table "Spare parts" are to be **only** ordered in the indicated quantities.

**Incompatible with article 0500 4.

*Artikelen in de tabel "reserve onderdelen" kunnen **alleen** besteld worden in de aangegeven hoeveelheden.

**Niet te combineren met de artikelen 0500 4.

Ausführbare Schiebetür-Lösungen
Possible sliding solutions
Mogelijke oplossingen schuifdeuren

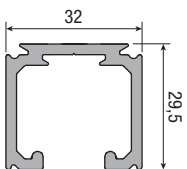
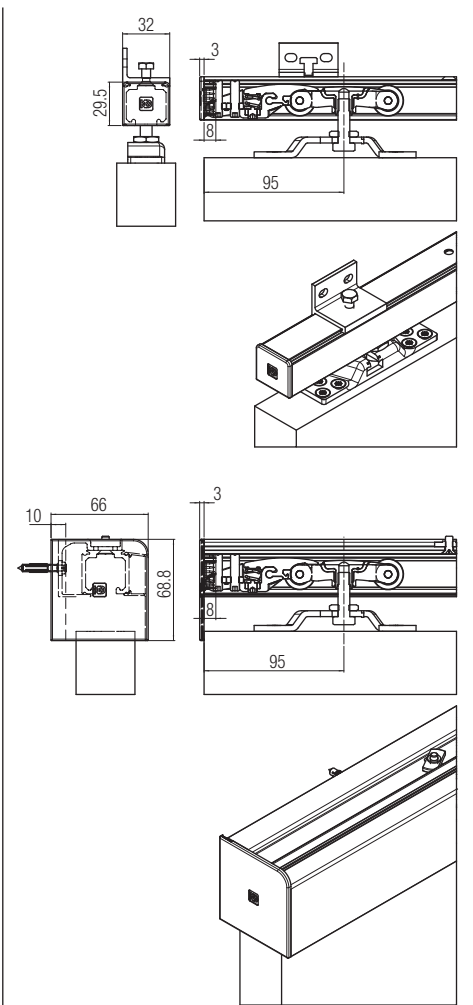
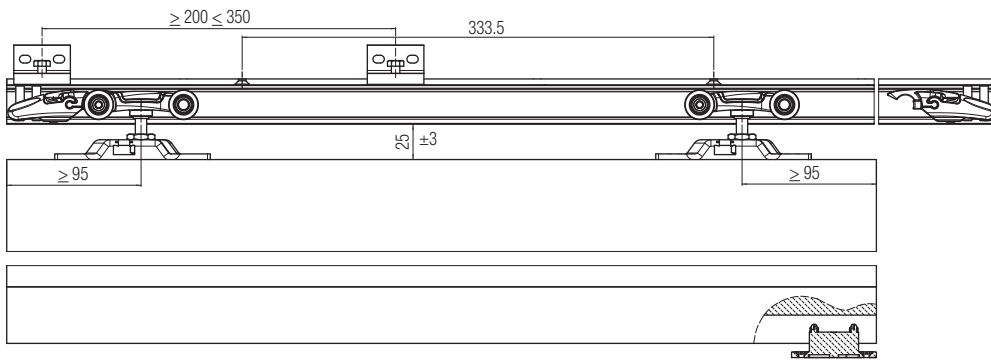
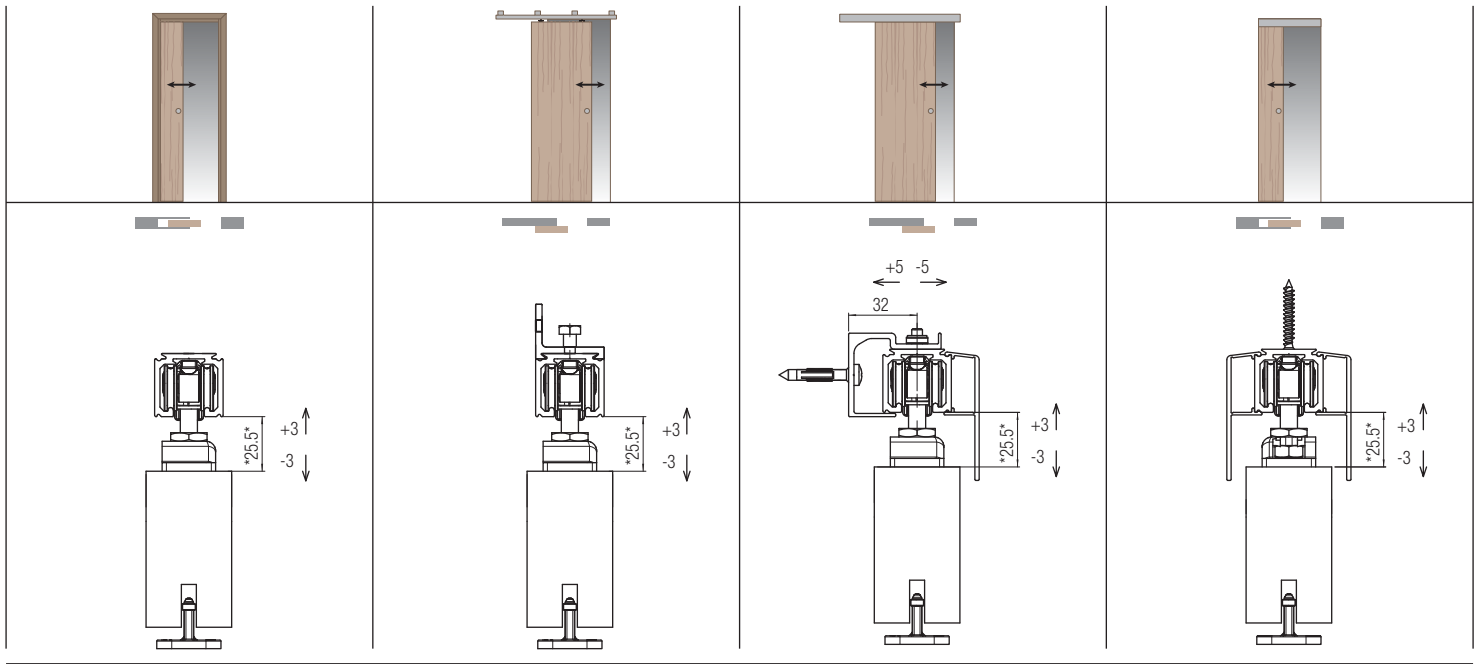

80 kg

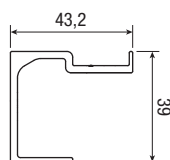

80 kg

